

Ed Walker

WING SPAN	60 INCHES
WING AREA	720 SQUARE INCHES
ENGINE	0.45 TO 0.61

JENSEN

Das Ugly Stik

DESIGNED BY PHIL KRAFT PLANS BY GEORGE A. WALKER

ASSEMBLY INSTRUCTIONS

- Preglue all splices and joints.
- Glue together wing spars and spar doublers. Note spar layout on drawing shows a splice on each side of wing centerline.
- Plywood insert in rudder.
- Plywood insert in elevator.
- Plywood insert on Ailerons.
- Fuselage sides are comprised of two pieces. Note that elevator push rod cutout is on the left hand fuselage side.
- Glue in hardwood inserts (at hatch location).
- Extension lines on the top view of fuselage drawing is for the purpose of marking the front edge of bulkheads and servo rails on bottom sheets (3/32" plywood front and 3/32" balsa rear) so fuselage can be built up off the drawings. Glue together in the following manner.

1. Two bottom sheets (Plywood and balsa)
2. Hardwood servo rails (3/8" x 1/2")
3. Bulkheads (epoxy F1)
4. Rudder supports (1/4" x 1/4")

PLACE ASIDE FOR GLUE TO DRY

- Stabilizer is NOT constructed on the drawing. The drawing is for reference only. Glue stabilizer together on a flat surface in the following manner:

1. Two bottom sheets (1/16")
2. Trailing edge spar (3/16" x 3/4") flush to edge of rear sheet.
3. Stabilize tips (3/16" x 3/4") flush to outer edge of sheets.
4. Leading edge spar (3/16" x 3/4") flush to edge of front sheet.

Ribs (1/8" x 3/16") start at the leading edge of tips and work towards the center; the center ribs are the only ones that will have to be cut to length.

PLACE ASIDE FOR GLUE TO DRY.

- Glue and pin fin together and place aside to dry.

- The wing is easier to build on a simple jig made up from two pieces of 3/4" plywood (12" x 30") nailed down at the center and blocked up 1-1/2" - 2" out from the center line. Lay wing drawings (left and right) on the jig and construct wing in the following order.

- Glue bottom trailing edge sheets at the center lap and pin down to jig.
- Cut off trailing edge sheet at the outside of wing tip and score the trailing edge sheet about halfway through at the tip rib location (W5). Block up the front corner of the trailing edge sheet 3/16" while keeping the back edge flat on the jig.

- Lay bottom main spar down but do not pin until all ribs are in place.
- Glue ribs in proper order, pulling them back against the trailing edge.
- Pin down bottom main spar.

- Glue and insert top main spar.
- Glue and pin on leading edge (3/8" x 3/8").
- Glue and insert top secondary spar (3/16" x 3/16"). Note that the lap is off to the side of W1.
- Cut off top trailing edge sheet to length and score on the inside (same as the bottom trailing edge sheet). Glue and pin in place.

- Glue and pin the tip of the top trailing edge sheet together with the bottom trailing edge sheet.
- Glue and insert false ribs (W6).
- Cut off leading edge flush with (W3) and glue on wing tips.

PLACE ASIDE FOR GLUE TO DRY

- Glue on stabilizer top sheets and place into position at rear of fuselage assembly.
- Insert nylon push rod tubing into F2 & F3.

NOTE

Before attempting this next step READ THE INSTRUCTIONS THOROUGHLY before proceeding.

- Epoxy is used at fuselage station F1 so spread epoxy on fuselage sides and F1 bulkhead. Now apply regular glue to the bottom of fuselage sides, bottom sheets, bulkheads and stabilizer. Pin sides in place. Dowels (at wing location) can be inserted through fuselage and rubber bands stretched over the top to hold fuselage together. Now clamp sides to F1 bulkhead, epoxy and insert 5/16" trailing edge stock.

- Glue on top back fuselage sheet (1/8") placing rudder pushrod cutout on right hand side.
- Glue fin into position. (Tail end of fuselage at fin slot may need trimming to accept the fin).
- Glue on top front fuselage piece (1/4") with beveled edge to the rear forming part of the wing cutout.

- Glue plywood hatch support (3/32" x 1/2" x 3-1/2") into place.
- Glue hatch stop to inside of hatch at front end.

This completes basic fuselage construction.

- When wing is completely dry remove from jig and glue in the bottom secondary spar (3/16" x 3/16").
- Glue bellcrank mounts into position.

- Cut the servo rail notches 3/32" deeper in W1 and glue in the servo rails flush with the bottom of the two W2 ribs.

- W1, trailing edge, bottom main spar, and bottom secondary spar are trimmed and sanded flat between the two W2 ribs to correspond with the servo rails. The leading edge is sanded flat ONLY on the front to fit against the bevel of the top front fuselage piece.

- When wing is sanded to completion, cover bottom of wing first then add 4/40" x 1" bellcrank pivot screws and nuts. Glue heads of the screws before covering top side of wing.
- After removing fuselage assembly from work-bench, glue into position the plywood landing gear stop (3/32" x 1/2" x 4").

CONCLUSION

The center of gravity on the drawing is an indicating point from which to start. The center of gravity will vary with the difference in weight of each model.

If the plane tries to "wind in" when banked in a turn, this indicates it is nose heavy and weight should be added to the tail. When the proper center of gravity is reached the plane will stay in a turn with just the application of elevator and will not climb or drop off. The glide after the engine stops or on low speed, should be corrected with transmitted trim.

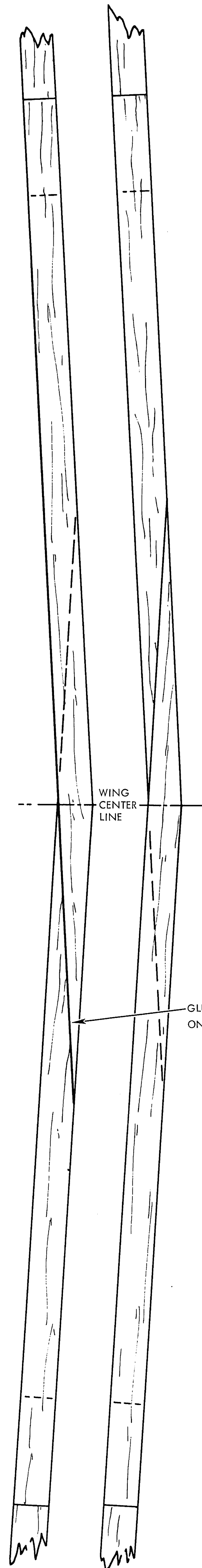

SPAR LAYOUT

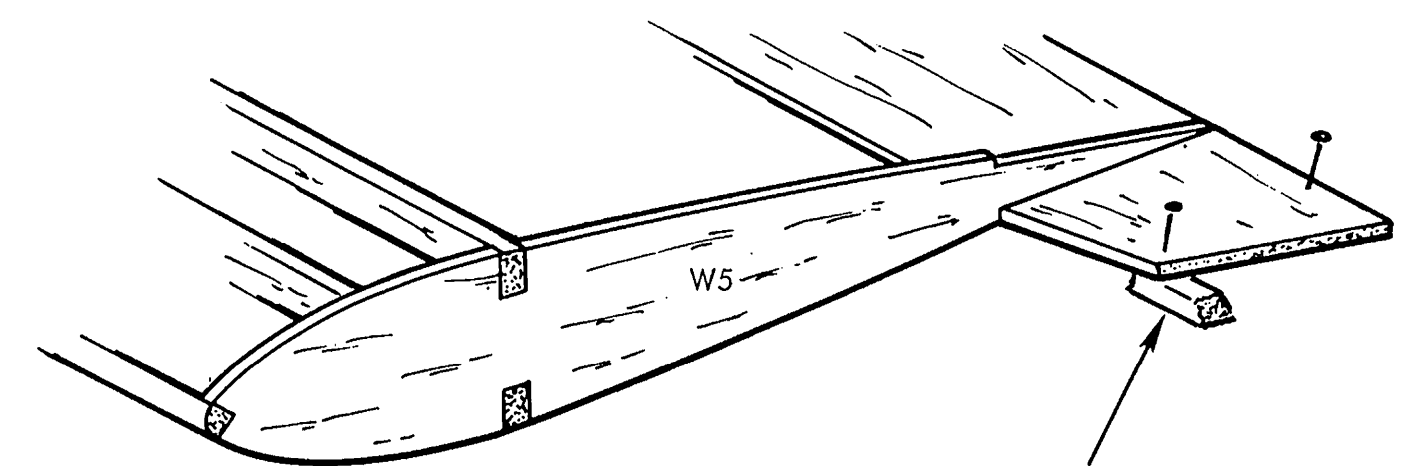
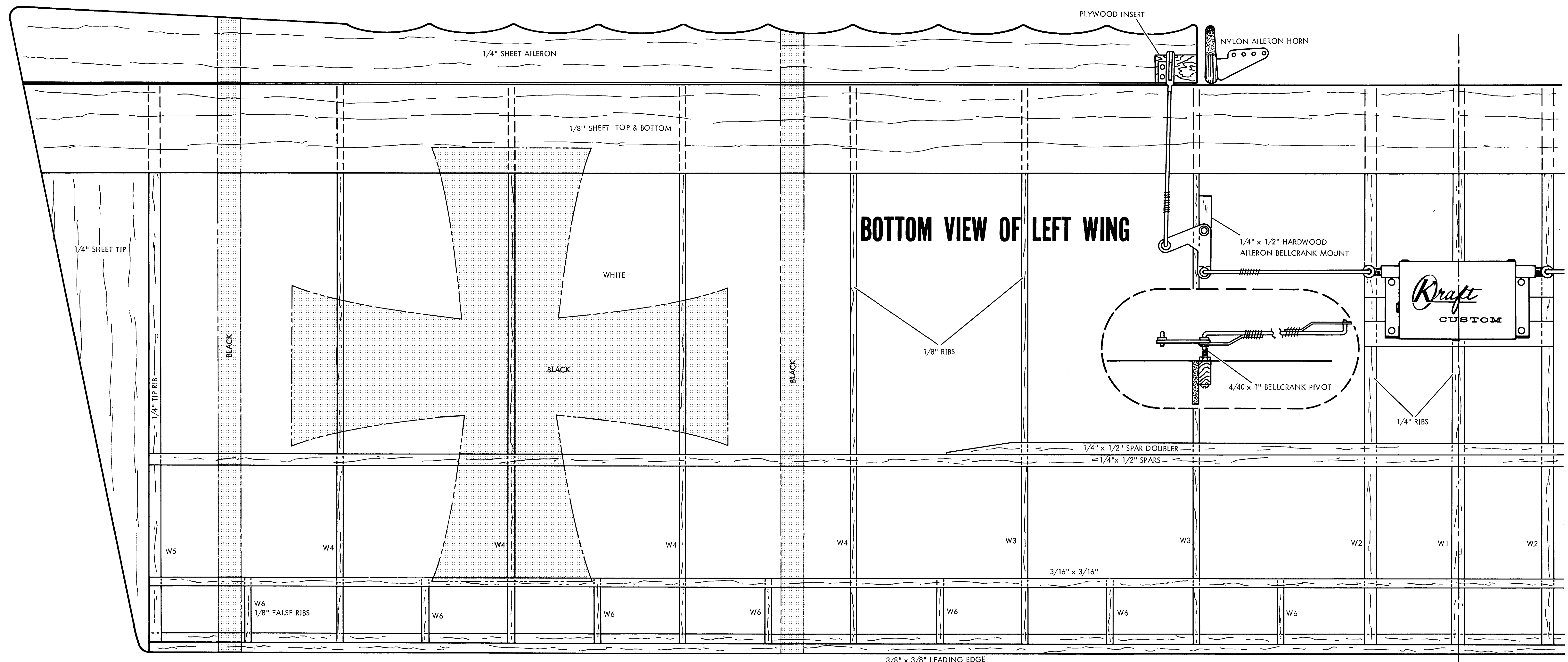

BLOCK UP FRONT CORNER OF BOTTOM TRAILING EDGE TIP 3/16"

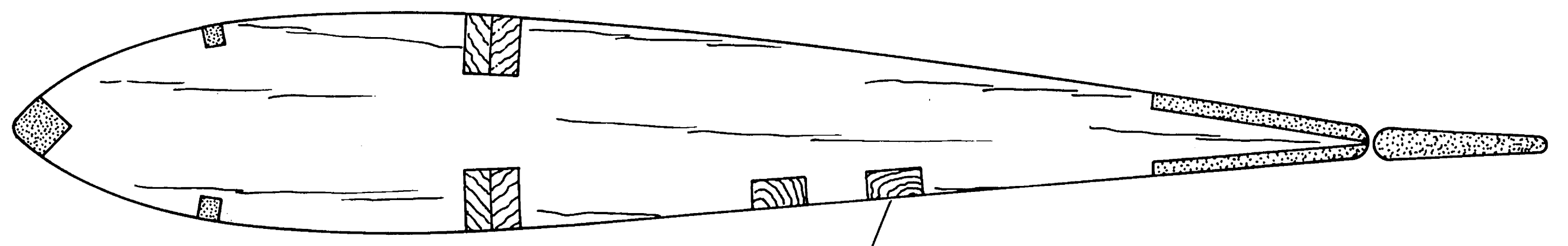

1/4" x 1/2" HARDWOOD SERVO RAILS

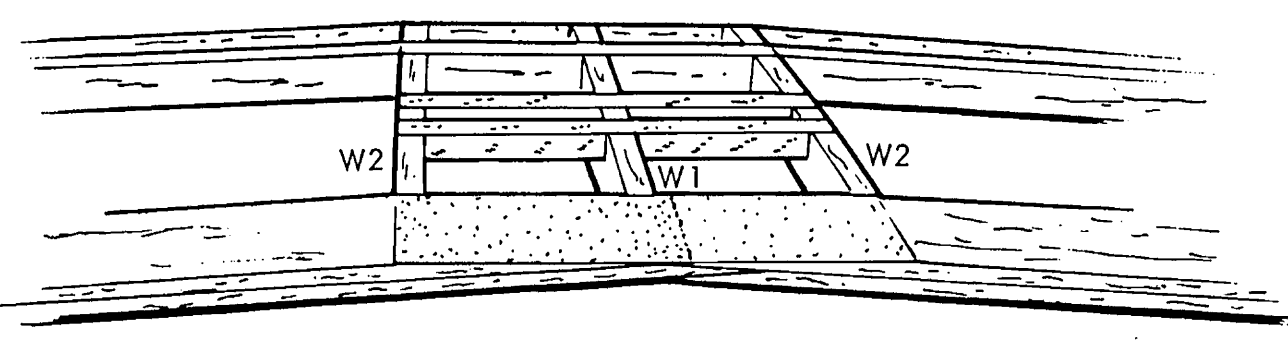

NOTE
GLUE SPARS SO THERE IS A SPLICE ON EACH SIDE OF WING CENTER LINE

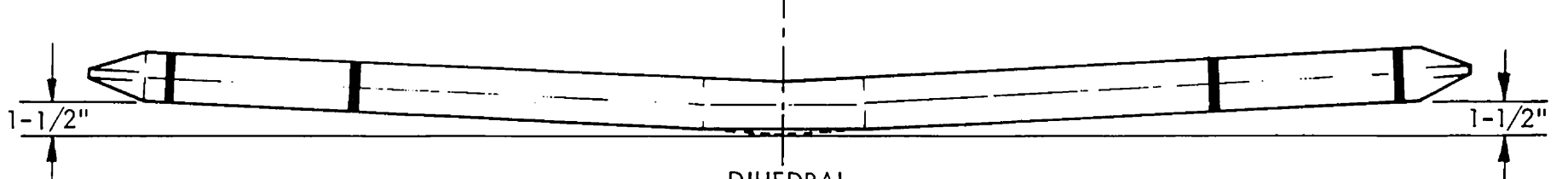
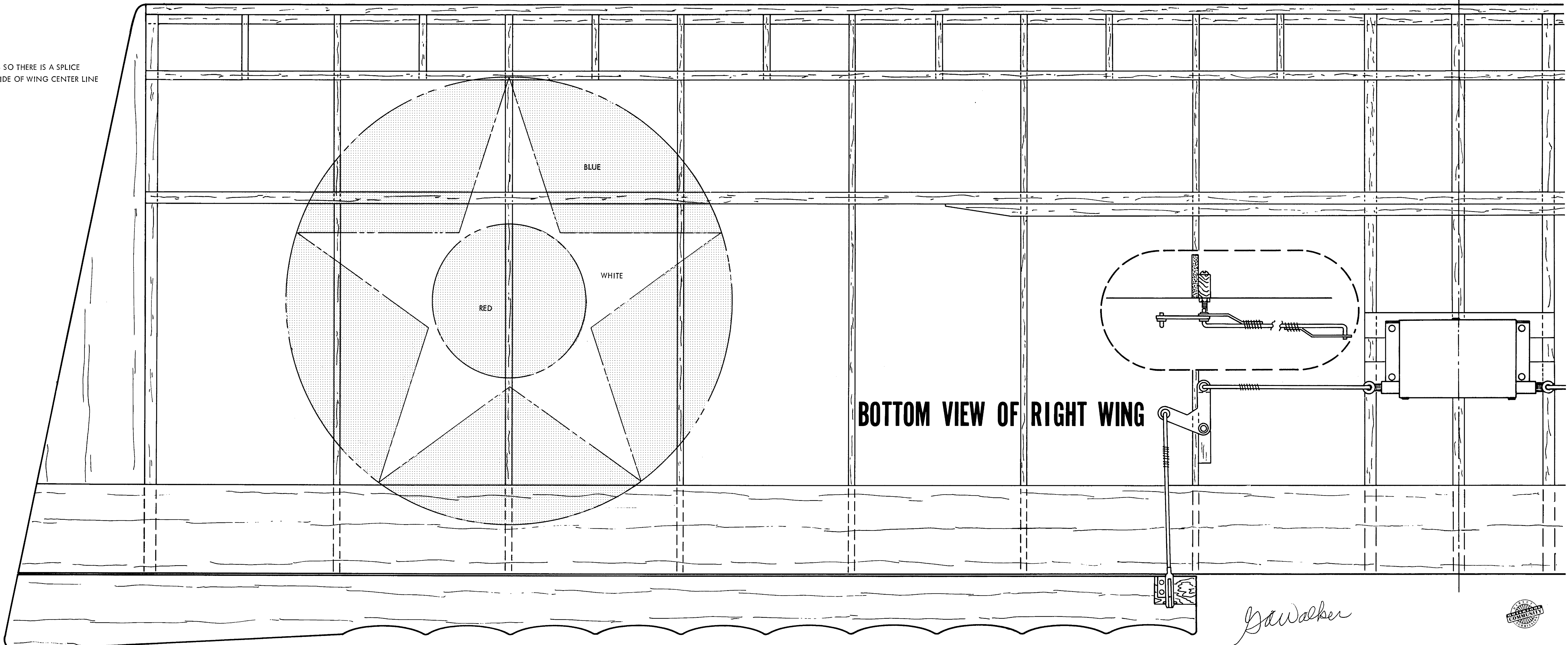

George A. Walker

JENSEN

Das Naly Stik

DESIGNED BY PHIL KRAFT PLANS BY GEORGE A. WALKER